

## FEATURES

- Low Power:  $I_{CC} = 300\mu\text{A}$  Typ
- Designed for RS485 Interface Applications
- Single 5V Supply
- $-7\text{V}$  to  $12\text{V}$  Bus Common Mode Range Permits  $\pm 7\text{V}$  Ground Difference Between Devices on the Bus
- Thermal Shutdown Protection
- Power-Up/Down Glitch-Free Driver Outputs Permit Live Insertion or Removal of Transceiver
- Driver Maintains High Impedance in Three-State or with the Power Off
- Combined Impedance of a Driver Output and Receiver Allows Up to 32 Transceivers on the Bus
- $70\text{mV}$  Typical Input Hysteresis
- $30\text{ns}$  Typical Driver Propagation Delays with  $5\text{ns}$  Skew for Up to  $2.5\text{MB}$  Operation
- Pin Compatible with  $\pm 60\text{V}$  Protected LTC2862

## APPLICATIONS

- Low Power RS485/RS422 Transceiver
- Level Translator

## DESCRIPTION

The **LTC<sup>®</sup>485** is a low power differential bus/line transceiver designed for multipoint data transmission standard RS485 applications with extended common mode range ( $12\text{V}$  to  $-7\text{V}$ ). It also meets the requirements of RS422.

The CMOS design offers significant power savings over its bipolar counterpart without sacrificing ruggedness against overload or ESD damage.

The driver and receiver feature three-state outputs, with the driver outputs maintaining high impedance over the entire common mode range. Excessive power dissipation caused by bus contention or faults is prevented by a thermal shutdown circuit which forces the driver outputs into a high impedance state.

The receiver has a fail-safe feature which guarantees a high output state when the inputs are left open.

The LTC485 is fully specified over the commercial and extended industrial temperature range.

LT, LT, LTC, LTM, Linear Technology and the Linear logo are registered trademarks of Linear Technology Corporation. All other trademarks are the property of their respective owners.

## TYPICAL APPLICATION

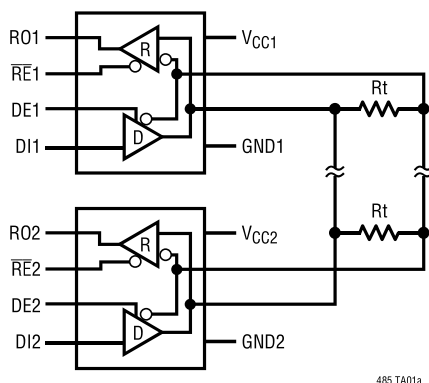

Driver Outputs

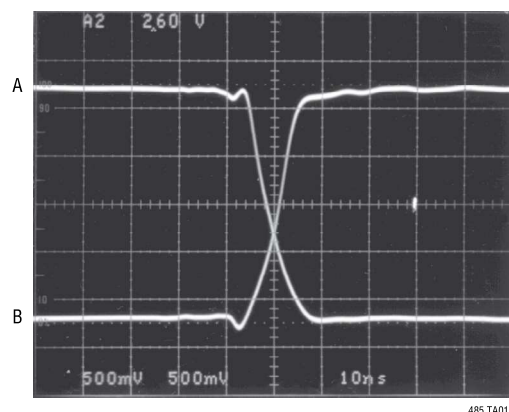

## ABSOLUTE MAXIMUM RATINGS

(Note 1)

Supply Voltage .....	12V
Control Input Voltages .....	-0.5V to $V_{CC} + 0.5V$
Driver Input Voltage .....	-0.5V to $V_{CC} + 0.5V$
Driver Output Voltage .....	$\pm 14V$
Receiver Input Voltage .....	$\pm 14V$
Receiver Output Voltages .....	-0.5V to $V_{CC} + 0.5V$
Operating Temperature Range	
LTC485I .....	$-40^{\circ}C \leq T_A \leq 85^{\circ}C$
LTC485C .....	$0^{\circ}C \leq T_A \leq 70^{\circ}C$
LTC485M (OBSOLETE) .....	$-55^{\circ}C \leq T_A \leq 125^{\circ}C$
Lead Temperature (Soldering, 10 sec) .....	300°C
Storage Temperature Range .....	$-65^{\circ}C$ to $150^{\circ}C$

## PIN CONFIGURATION

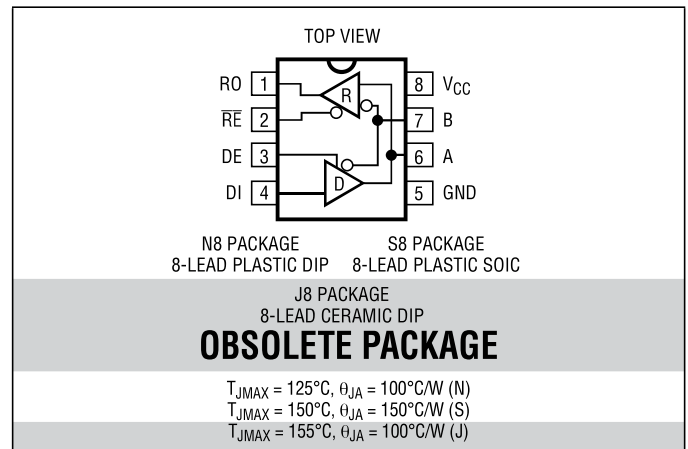

## ORDER INFORMATION

<http://www.linear.com/product/LTC485#orderinfo>

LEAD FREE FINISH	TAPE AND REEL	PART MARKING*	PACKAGE DESCRIPTION	TEMPERATURE RANGE
LTC485CN8#PBF	NA	LTC485CN8	8-Lead Plastic DIP	0°C to 70°C
LTC485CS8#PBF	LTC485CS8#TRPBF	485	8-Lead Plastic SOIC	0°C to 70°C
LTC485IN8#PBF	NA	LTC485IN8	8-Lead Plastic DIP	-40°C to 85°C
LTC485IS8#PBF	LTC485IS8#TRPBF	485I	8-Lead Plastic SOIC	-40°C to 85°C
LEAD BASED FINISH	TAPE AND REEL	PART MARKING*	PACKAGE DESCRIPTION	TEMPERATURE RANGE
LTC485CN8	NA	LTC485CN8	8-Lead Plastic DIP	0°C to 70°C
LTC485CS8	LTC485CS8#TR	485	8-Lead Plastic SOIC	0°C to 70°C
LTC485IN8	NA	LTC485IN8	8-Lead Plastic DIP	-40°C to 85°C
LTC485IS8	LTC485IS8#TR	485I	8-Lead Plastic SOIC	-40°C to 85°C
OBSOLETE PACKAGE				
LTC485MJ8	NA	LTC485MJ8	8-Lead Ceramic DIP	-55°C to 125°C

Consult LTC Marketing for parts specified with wider operating temperature ranges. \*The temperature grade is identified by a label on the shipping container.

For more information on lead free part marking, go to: <http://www.linear.com/leadfree/>

For more information on tape and reel specifications, go to: <http://www.linear.com/tapeandree/>. Some packages are available in 500 unit reels through designated sales channels with #TRMPBF suffix.

## ELECTRICAL CHARACTERISTICS

The ● denotes the specifications which apply over the full operating temperature range, otherwise specifications are at  $T_A = 25^{\circ}C$ .  $V_{CC} = 5V \pm 5\%$ , unless otherwise noted. (Notes 2 and 3)

SYMBOL	PARAMETER	CONDITIONS	MIN	TYP	MAX	UNITS
$V_{OD1}$	Differential Driver Output Voltage (Unloaded)	$I_O = 0$	●	5		V
$V_{OD2}$	Differential Driver Output Voltage (with Load)	R = 50Ω (RS422) R = 27Ω (RS485), Figure 1	●	2		V
			●	1.5	5	V
$\Delta V_{OD}$	Change in Magnitude of Driver Differential Output Voltage for Complementary States	R = 27Ω or R = 50Ω, Figure 1	●		0.2	V
$V_{OC}$	Driver Common Mode Output Voltage	R = 27Ω or R = 50Ω, Figure 1	●		3	V
$\Delta  V_{OC} $	Change in Magnitude of Driver Common Mode Output Voltage for Complementary States	R = 27Ω or R = 50Ω, Figure 1	●		0.2	V

485fm

## ELECTRICAL CHARACTERISTICS

The ● denotes the specifications which apply over the full operating temperature range, otherwise specifications are at  $T_A = 25^\circ\text{C}$ .  $V_{CC} = 5V \pm 5\%$ , unless otherwise noted. (Notes 2 and 3)

SYMBOL	PARAMETER	CONDITIONS	MIN	TYP	MAX	UNITS
$V_{IH}$	Input High Voltage	DE, DI, $\overline{RE}$	●	2		V
$V_{IL}$	Input Low Voltage	DE, DI, $\overline{RE}$	●		0.8	V
$I_{IN1}$	Input Current	DE, DI, $\overline{RE}$	●		$\pm 2$	$\mu\text{A}$
$I_{IN2}$	Input Current (A, B)	DE = 0, $V_{CC} = 0V$ or 5.25V C-, I-Grade	●		1	$\text{mA}$
			●		-0.8	$\text{mA}$
		M-Grade	●		2	$\text{mA}$
			●		-1.6	$\text{mA}$
$V_{TH}$	Differential Input Threshold Voltage for Receiver	$-7V \leq V_{CM} \leq 12V$	●	-0.2	0.2	V
$\Delta V_{TH}$	Receiver Input Hysteresis	$V_{CM} = 0V$	●	70		mV
$V_{OH}$	Receiver Output High Voltage	$I_O = -4\text{mA}$ , $V_{ID} = 200\text{mV}$	●	3.5		V
$V_{OL}$	Receiver Output Low Voltage	$I_O = 4\text{mA}$ , $V_{ID} = -200\text{mV}$	●		0.4	V
$I_{OZR}$	Three-State (High Impedance) Output Current at Receiver	$V_{CC} = \text{Max}$ , $0.4V \leq V_O \leq 2.4V$	●		$\pm 1$	$\mu\text{A}$
$R_{IN}$	Receiver Input Resistance	$-7V \leq V_{CM} \leq 12V$ (C-, I-Grade)	●	12		$\text{k}\Omega$
		(M-Grade)	●	6		$\text{k}\Omega$

## SWITCHING CHARACTERISTICS

The ● denotes the specifications which apply over the full operating temperature range, otherwise specifications are at  $T_A = 25^\circ\text{C}$ .  $V_{CC} = 5V \pm 5\%$ , unless otherwise noted. (Notes 2 and 3)

SYMBOL	PARAMETER	CONDITIONS	MIN	TYP	MAX	UNITS	
$I_{CC}$	Supply Current	No Load, Pins 2, 3, 4 = 0V or 5V	●			$\mu\text{A}$	
		Outputs Enabled	●	500	900	$\mu\text{A}$	
		Outputs Disabled	●	300	500	$\mu\text{A}$	
$I_{OSD1}$	Driver Short-Circuit Current, $V_{OUT} = \text{HIGH}$	$V_O = -7V$	●	35	100	250	$\text{mA}$
$I_{OSD2}$	Driver Short-Circuit Current, $V_{OUT} = \text{LOW}$	$V_O = 10V$	●	35	100	250	$\text{mA}$
$I_{OSR}$	Receiver Short-Circuit Current	$0V \leq V_O \leq V_{CC}$	●	7		85	$\text{mA}$
$t_{PLH}$	Driver Input to Output	$R_{DIFF} = 54\Omega$ , $C_{L1} = C_{L2} = 100\text{pF}$ , (Figures 3 and 5)	●	10	30	50	ns
$t_{PHL}$	Driver Input to Output		●	10	30	50	ns
$t_{SKEW}$	Driver Output to Output		●		5	10	ns
$t_r, t_f$	Driver Rise or Fall Time		●	3	15	25	ns
$t_{ZH}$	Driver Enable to Output High	$C_L = 100\text{pF}$ (Figures 4 and 6) S2 Closed	●		40	70	ns
$t_{ZL}$	Driver Enable to Output Low	$C_L = 100\text{pF}$ (Figures 4 and 6) S1 Closed	●		40	70	ns
$t_{LZ}$	Driver Disable Time from Low	$C_L = 15\text{pF}$ (Figures 4 and 6) S1 Closed	●		40	70	ns
$t_{HZ}$	Driver Disable Time from High	$C_L = 15\text{pF}$ (Figures 4 and 6) S2 Closed	●		40	70	ns
$t_{PLH}$	Receiver Input to Output	$R_{DIFF} = 54\Omega$ , $C_{L1} = C_{L2} = 100\text{pF}$ , (Figures 3 and 7)	●	30	90	200	ns
$t_{PHL}$			●	30	90	200	ns
$t_{SKD}$	$ t_{PLH} - t_{PHL} $ Differential Receiver Skew		●		13		ns
$t_{ZL}$	Receiver Enable to Output Low	$C_{RL} = 15\text{pF}$ (Figures 2 and 8) S1 Closed	●		20	50	ns
$t_{ZH}$	Receiver Enable to Output High	$C_{RL} = 15\text{pF}$ (Figures 2 and 8) S2 Closed	●		20	50	ns
$t_{LZ}$	Receiver Disable from Low	$C_{RL} = 15\text{pF}$ (Figures 2 and 8) S1 Closed	●		20	50	ns
$t_{HZ}$	Receiver Disable from High	$C_{RL} = 15\text{pF}$ (Figures 2 and 8) S2 Closed	●		20	50	ns

**Note 1:** Stresses beyond those listed under Absolute Maximum Ratings may cause permanent damage to the device. Exposure to any Absolute Maximum Rating condition for extended periods may affect device reliability and lifetime.

**Note 2:** All currents into device pins are positive; all currents out of device pins are negative. All voltages are referenced to device ground unless otherwise specified.

**Note 3:** All typicals are given for  $V_{CC} = 5V$  and  $T_A = 25^\circ\text{C}$ .

**Note 4:** The LTC485 is guaranteed by design to be functional over a supply voltage range of  $5V \pm 10\%$ . Data sheet parameters are guaranteed over the tested supply voltage range of  $5V \pm 5\%$ .

**TYPICAL PERFORMANCE CHARACTERISTICS**

**Receiver Output Low Voltage vs Output Current**

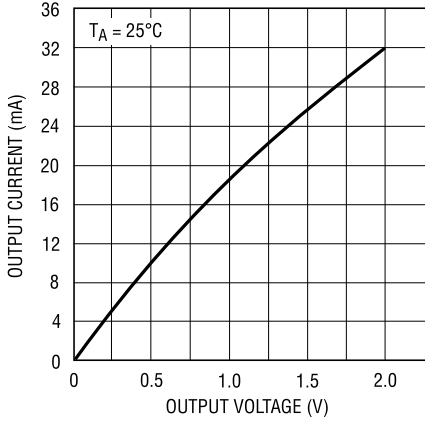

485 G01

**Receiver Output High Voltage vs Output Current**

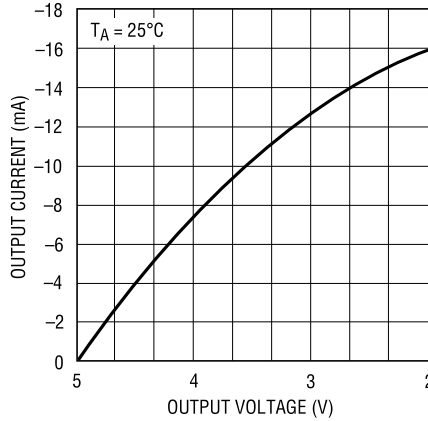

485 G02

**Receiver Output High Voltage vs Temperature**

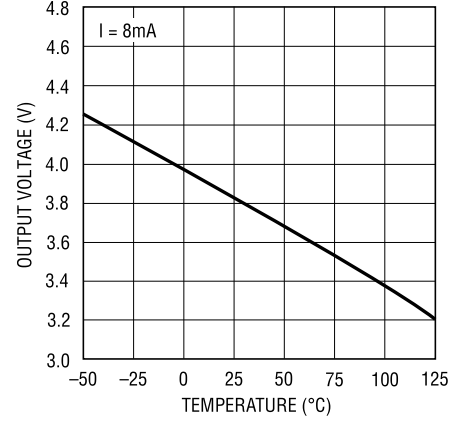

485 G03

**Receiver Output Low Voltage vs Temperature**

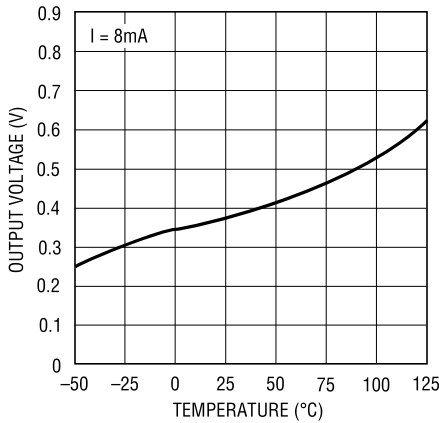

485 G04

**Driver Differential Output Voltage vs Output Current**

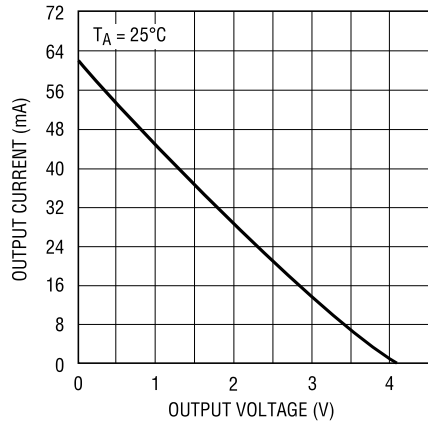

485 G05

**Driver Differential Output Voltage vs Temperature**

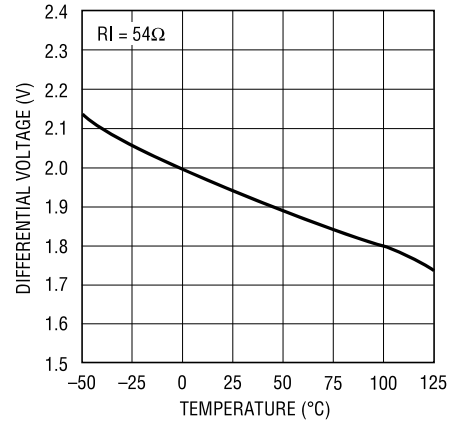

485 G06

**Driver Output Low Voltage vs Output Current**

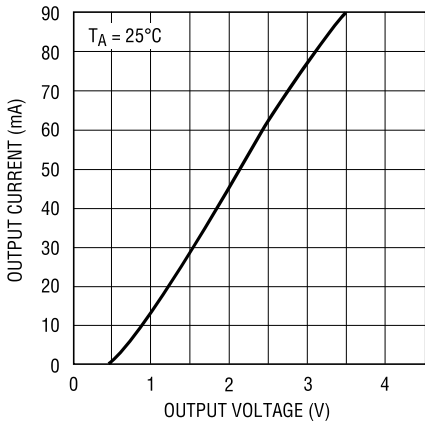

485 G07

**Driver Output High Voltage vs Output Current**

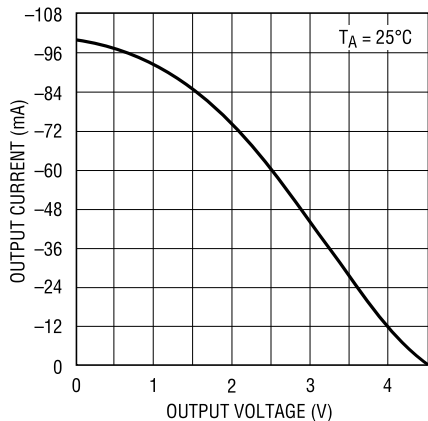

485 G08

**TTL Input Threshold vs Temperature**

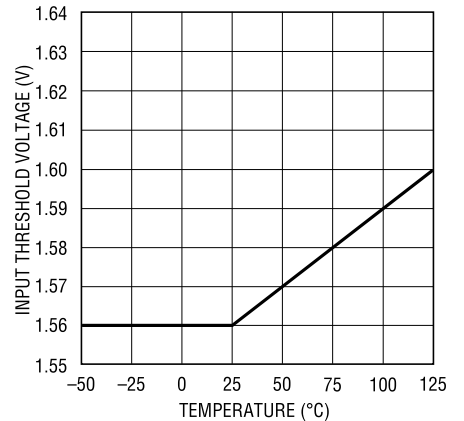

485 G09

## TYPICAL PERFORMANCE CHARACTERISTICS

Receiver  $|t_{PLH} - t_{PHL}|$   
vs Temperature

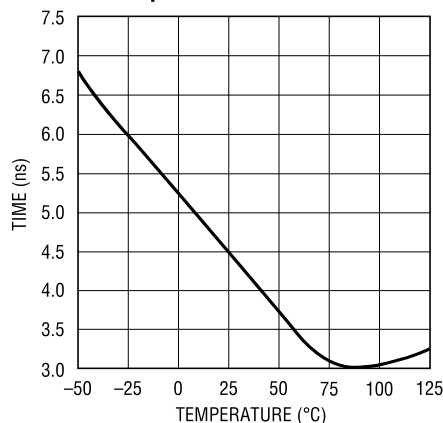

485 G10

Driver Skew vs Temperature

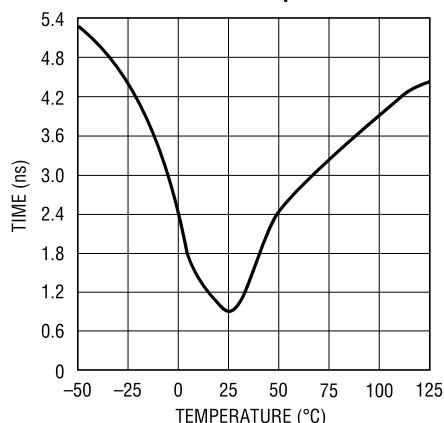

485 G11

Supply Current vs Temperature

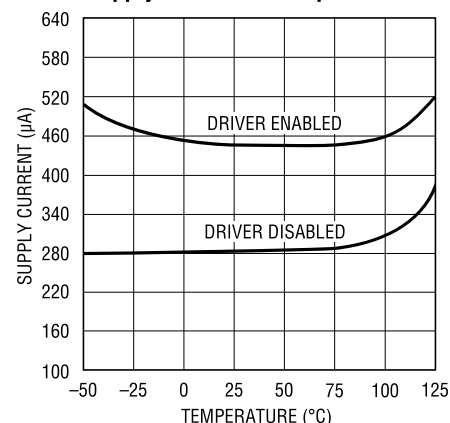

485 G12

## PIN FUNCTIONS

**RO (Pin 1):** Receiver Output. If the receiver output is enabled ( $\overline{RE}$  low), then if  $A > B$  by 200mV, RO will be high. If  $A < B$  by 200mV, then RO will be low.

**$\overline{RE}$  (Pin 2):** Receiver Output Enable. A low enables the receiver output, RO. A high input forces the receiver output into a high impedance state.

**DE (Pin 3):** Driver Output Enable. A high on DE enables the driver outputs, A and B, and the chip will function as a line driver. A low input will force the driver outputs into a high impedance state and the chip will function as a line receiver.

**DI (Pin 4):** Driver Input. If the driver outputs are enabled (DE high), then a low on DI forces the outputs A low and B high. A high on DI with the driver outputs enabled will force A high and B low.

**GND (Pin 5):** Ground Connection.

**A (Pin 6):** Driver Output/Receiver Input.

**B (Pin 7):** Driver Output/Receiver Input.

**$V_{CC}$  (Pin 8):** Positive Supply;  $4.75 < V_{CC} < 5.25$ .

TEST CIRCUITS

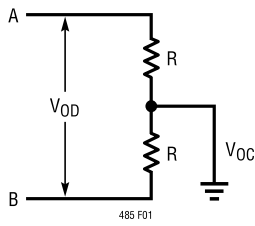

Figure 1. Driver DC Test Load

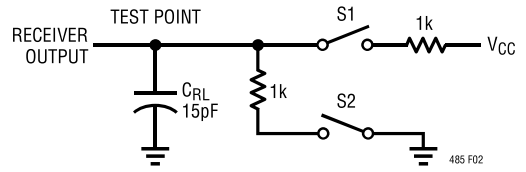

Figure 2. Receiver Timing Test Load

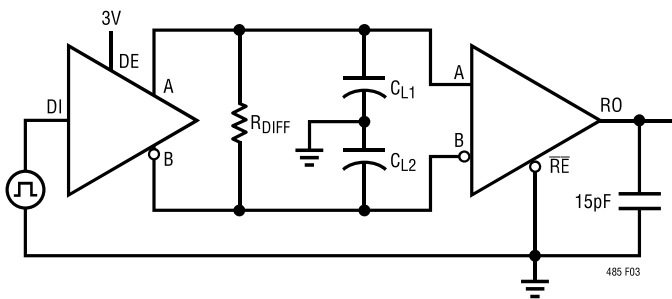

Figure 3. Driver/Receiver Timing Test Circuit

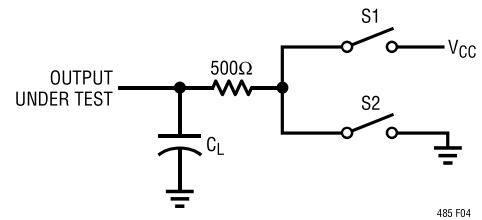

Figure 4. Driver Timing Test Load #2

SWITCHING TIME WAVEFORMS

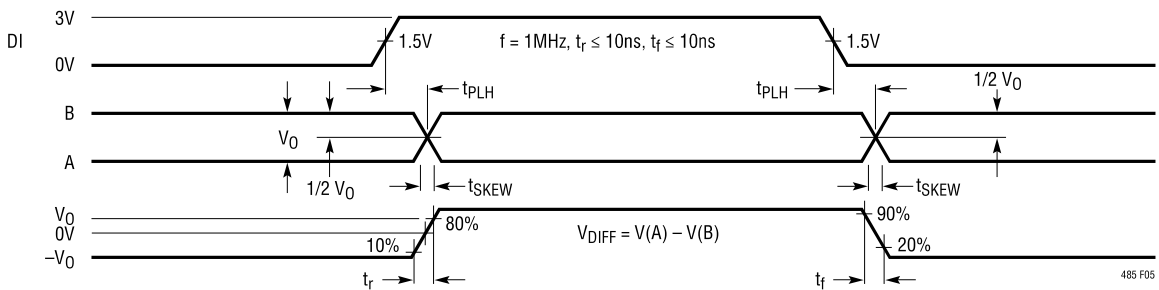

Figure 5. Driver Propagation Delays

## SWITCHING TIME WAVEFORMS

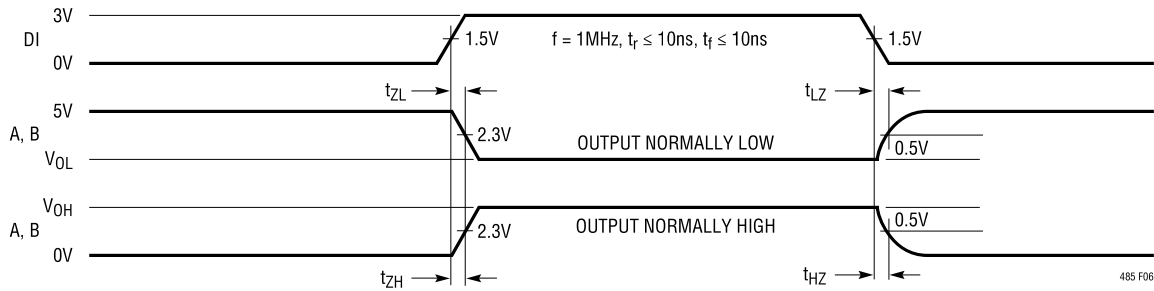

Figure 6. Driver Enable and Disable Times

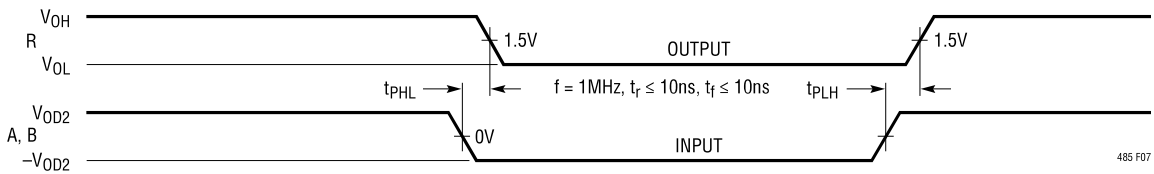

Figure 7. Receiver Propagation Delays

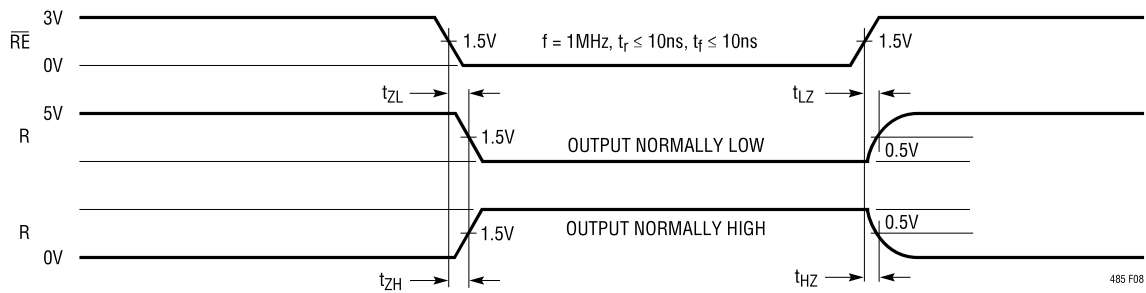

Figure 8. Receiver Enable and Disable Times

## FUNCTION TABLES

### LTC485 Transmitting

INPUTS			LINE CONDITION	OUTPUTS	
RE	DE	DI		B	A
X	1	1	No Fault	0	1
X	1	0	No Fault	1	0
X	0	X	X	Z	Z
X	1	X	Fault	Z	Z

### LTC485 Receiving

INPUTS			OUTPUTS
RE	DE	A - B	R
0	0	$\geq 0.2V$	1
0	0	$\leq -0.2V$	0
0	0	Inputs Open	1
1	0	X	Z

## APPLICATIONS INFORMATION

### Basic Theory of Operation

Previous RS485 transceivers have been designed using bipolar technology because the common mode range of the device must extend beyond the supplies and the device must be immune to ESD damage and latchup. Unfortunately, the bipolar devices draw a large amount of supply current, which is unacceptable for the numerous applications that require low power consumption. The LTC485 is the first CMOS RS485/RS422 transceiver which features ultralow power consumption without sacrificing ESD and latchup immunity.

The LTC485 uses a proprietary driver output stage, which allows a common-mode range that extends beyond the power supplies while virtually eliminating latchup and providing excellent ESD protection. Figure 9 shows the LTC485 output stage while Figure 10 shows a conventional CMOS output stage.

When the conventional CMOS output stage of Figure 10 enters a high impedance state, both the P-channel (P1) and the N-channel (N1) are turned off. If the output is then driven above  $V_{CC}$  or below ground, the P + /N-well

diode (D1) or the N + /P-substrate diode (D2) respectively will turn on and clamp the output to the supply. Thus, the output stage is no longer in a high impedance state and is not able to meet the RS485 common mode range requirement. In addition, the large amount of current flowing through either diode will induce the well known CMOS latchup condition, which could destroy the device.

The LTC485 output stage of Figure 9 eliminates these problems by adding two Schottky diodes, SD3 and SD4. The Schottky diodes are fabricated by a proprietary modification to the standard N-well CMOS process. When the output stage is operating normally, the Schottky diodes are forward biased and have a small voltage drop across them. When the output is in the high impedance state and is driven above  $V_{CC}$  or below ground, the parasitic diodes D1 or D2 still turn on, but SD3 or SD4 will reverse bias and prevent current from flowing into the N-well or the substrate. Thus, the high impedance state is maintained even with the output voltage beyond the supplies. With no minority carrier current flowing into the N-well or substrate, latchup is virtually eliminated under power-up or power-down conditions.

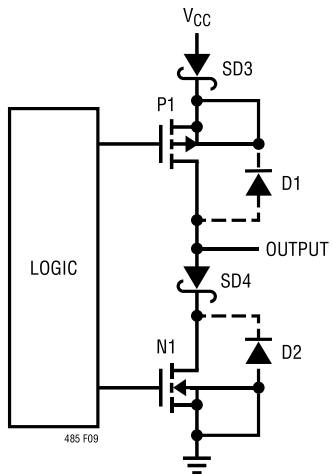

Figure 9. LTC485 Output Stage

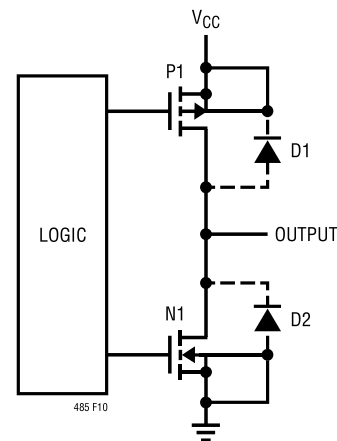

Figure 10. Conventional CMOS Output Stage



## APPLICATIONS INFORMATION

The LTC485 output stage will maintain a high impedance state until the breakdown of the N-channel or P-channel is reached when going positive or negative respectively. The output will be clamped to either  $V_{CC}$  or ground by a Zener voltage plus a Schottky diode drop, but this voltage is way beyond the RS485 operating range. This clamp protects the MOS gates from ESD voltages well over 2000V. Because the ESD injected current in the N-well or substrate consists of majority carriers, latchup is prevented by careful layout techniques.

### Propagation Delay

Many digital encoding schemes are dependent upon the difference in the propagation delay times of the driver and the receiver. Using the test circuit of Figure 13, Figures 11 and 12 show the typical LTC485 receiver propagation delay.

The receiver delay times are:

$$|t_{PLH} - t_{PHL}| = 9\text{ns Typ, } V_{CC} = 5\text{V}$$

The driver skew times are:

$$\text{Skew} = 5\text{ns Typ, } V_{CC} = 5\text{V}$$

$$10\text{ns Max, } V_{CC} = 5\text{V, } T_A = -40^\circ\text{C to } 85^\circ\text{C}$$

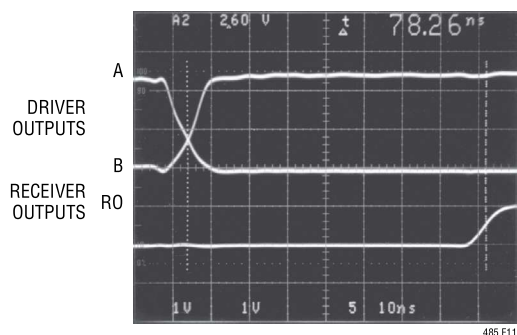

Figure 11. Receiver  $t_{PHL}$

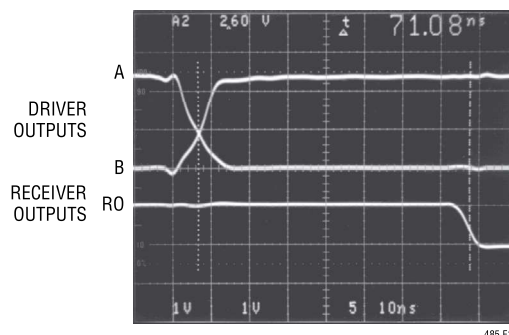

Figure 12. Receiver  $t_{PLH}$

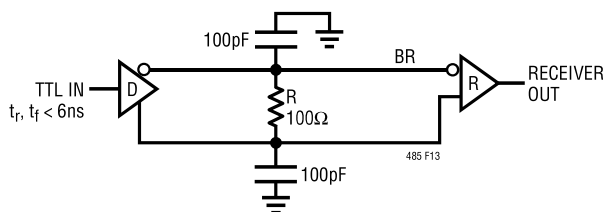

Figure 13. Receiver Propagation Delay Test Circuit

## APPLICATIONS INFORMATION

### LTC485 Line Length vs Data Rate

The maximum line length allowable for the RS422/RS485 standard is 4000 feet.

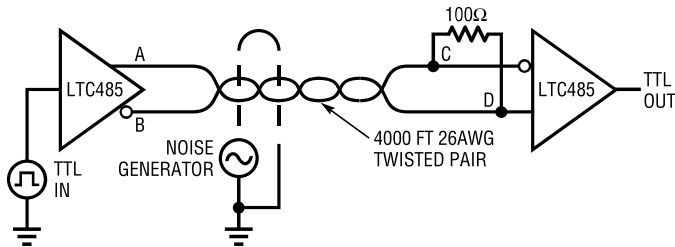

Figure 14. Line Length Test Circuit

Using the test circuit in Figure 14, Figures 15 and 16 show that with  $\sim 20V_{p-p}$  common mode noise injected on the line, the LTC485 is able to reconstruct the data stream at the end of 4000 feet of twisted pair wire.

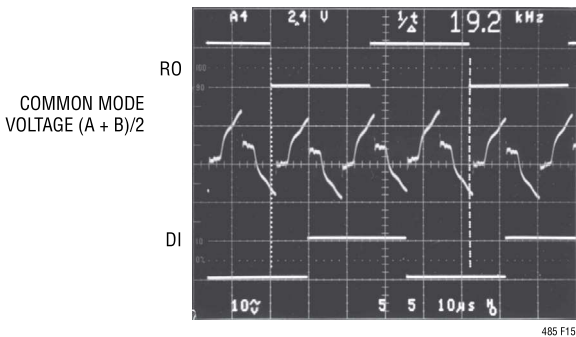

Figure 15. System Common Mode Voltage at 19.2kHz

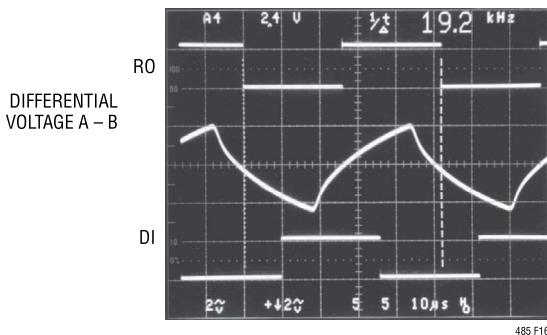

Figure 16. System Differential Voltage at 19.2kHz

Figures 17 and 18 show that the LTC485 is able to comfortably drive 4000 feet of wire at 110kHz.

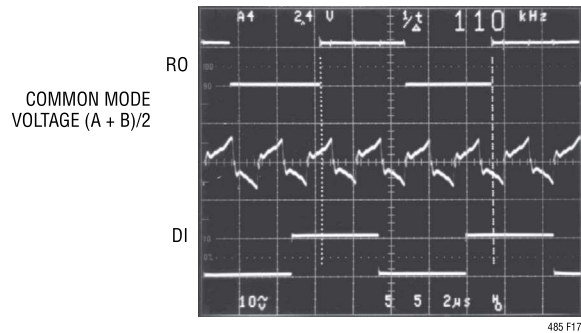

Figure 17. System Common Mode Voltage at 110kHz

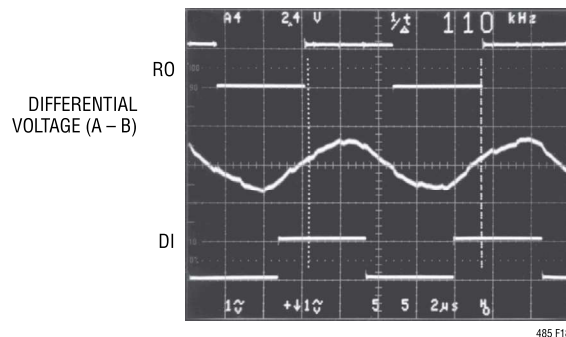

Figure 18. System Differential Voltage at 110kHz

When specifying line length vs maximum data rate the curve in Figure 19 should be used.

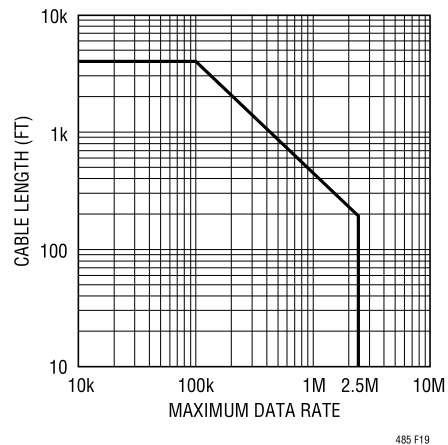
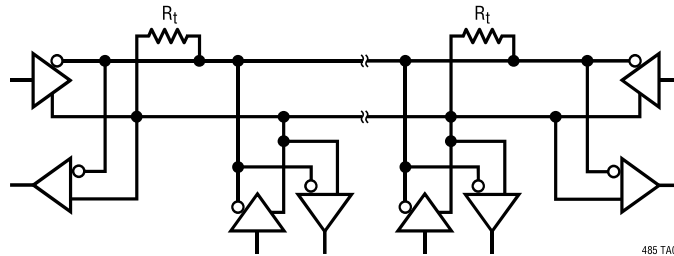

Figure 19. Cable Length vs Maximum Data Rate

# TYPICAL APPLICATION

Typical RS485 Network



485 TA02

# PACKAGE DESCRIPTION

Please refer to <http://www.linear.com/product/LTC485#packaging> for the most recent package drawings.

**J8 Package**  
**8-Lead CERDIP (Narrow .300 Inch, Hermetic)**  
 (Reference LTC DWG # 05-08-1110)

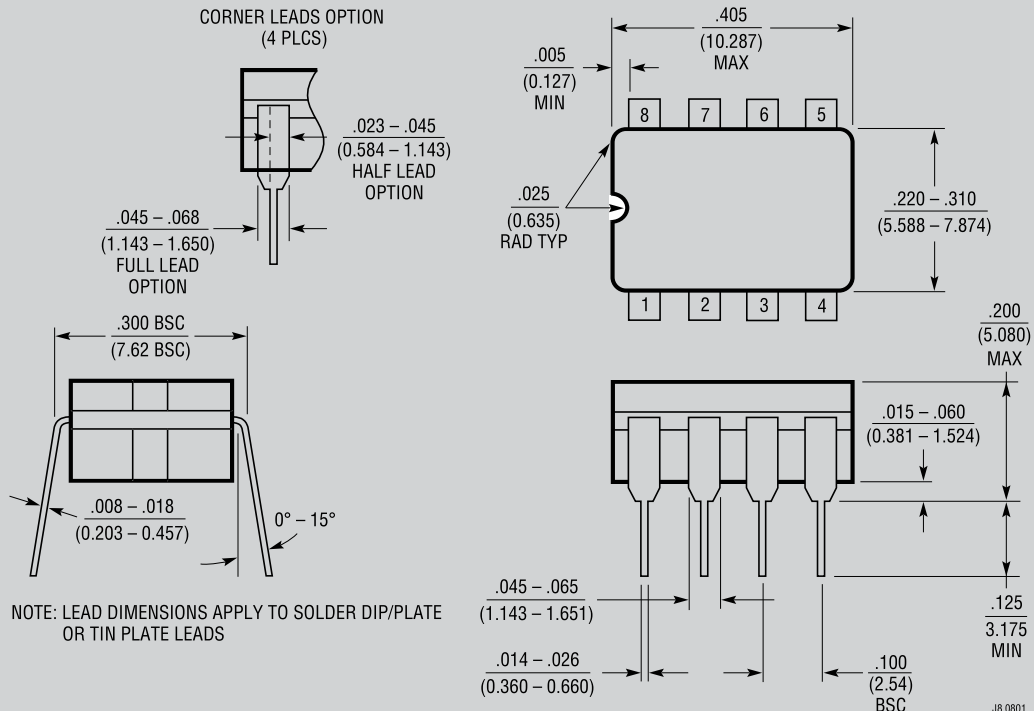

**OBSOLETE PACKAGE**

## PACKAGE DESCRIPTION

Please refer to <http://www.linear.com/product/LTC485#packaging> for the most recent package drawings.

### N Package 8-Lead PDIP (Narrow .300 Inch) (Reference LTC DWG # 05-08-1510 Rev I)

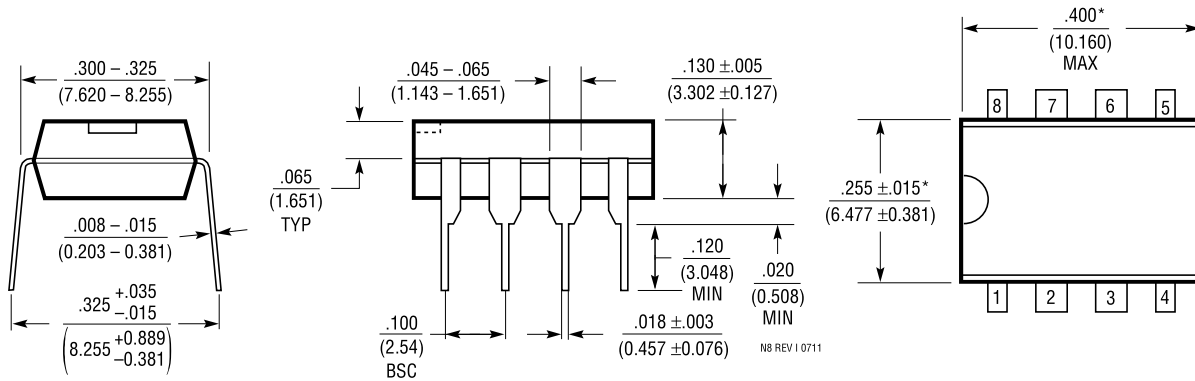

NOTE:

1. DIMENSIONS ARE  $\frac{\text{INCHES}}{\text{MILLIMETERS}}$

\*THESE DIMENSIONS DO NOT INCLUDE MOLD FLASH OR PROTRUSIONS.  
MOLD FLASH OR PROTRUSIONS SHALL NOT EXCEED .010 INCH (0.254mm)

### S8 Package 8-Lead Plastic Small Outline (Narrow .150 Inch) (Reference LTC DWG # 05-08-1610 Rev G)

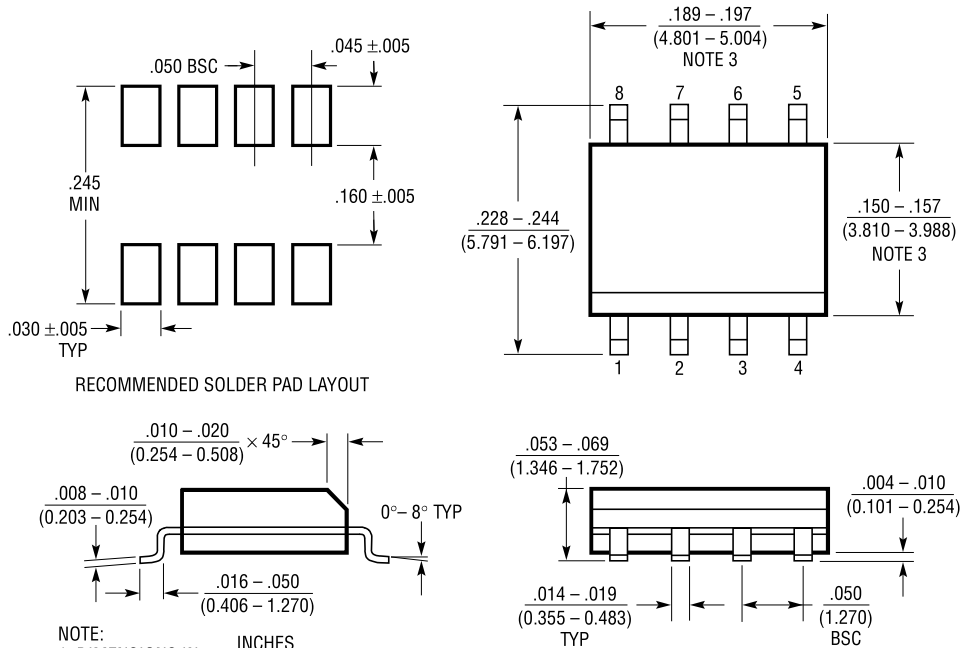

NOTE:

1. DIMENSIONS IN  $\frac{\text{INCHES}}{\text{MILLIMETERS}}$
2. DRAWING NOT TO SCALE
3. THESE DIMENSIONS DO NOT INCLUDE MOLD FLASH OR PROTRUSIONS.  
MOLD FLASH OR PROTRUSIONS SHALL NOT EXCEED .006" (0.15mm)
4. PIN 1 CAN BE BEVEL EDGE OR A DIMPLE

S08 REV G 0212

**REVISION HISTORY** (Revision history begins at Rev I)

REV	DATE	DESCRIPTION	PAGE NUMBER
I	4/11	Removed lead free version of LTC485MJ8 from Order Information section.	2
J	01/14	Modified to account for high temperature leakage in M-grade.	1, 3
K	02/14	Remove tape and reel option for DIP package in Order Information section.	2
L	07/16	Added storage temperature	2
M	02/17	Obsoleted J8 package	1-14

## RELATED PARTS

PART NUMBER	DESCRIPTION	COMMENTS
<a href="#">LTC486/LTC487</a>	Low Power Quad RS485 Drivers	110 $\mu$ A Supply Current
<a href="#">LTC488/LTC489</a>	Low Power Quad RS485 Receivers	7mA Supply Current
<a href="#">LTC490/LTC491</a>	Low Power Full-Duplex RS485 Transceivers	300 $\mu$ A Supply Current
<a href="#">LTC1480</a>	3.3V Supply RS485 Transceiver	Lower Supply Voltage
<a href="#">LTC1481</a>	Low Power RS485 Transceiver with Shutdown	Lowest Power
<a href="#">LTC1482</a>	RS485 Transceiver with Carrier Detect	$\pm$ 15kV ESD, Fail-Safe
<a href="#">LTC1483</a>	Low Power, Low EMI RS485 Transceiver	Slew Rate Limited Driver Outputs, Lowest Power
<a href="#">LTC1484</a>	RS485 Transceiver with Fail-Safe	$\pm$ 15kV ESD, MSOP Package
<a href="#">LTC1485</a>	10Mbps RS485 Transceiver	High Speed
<a href="#">LTC1518/LTC1519</a>	52Mbps Quad RS485 Receivers	Higher Speed, LTC488/LTC489 Pin-Compatible
<a href="#">LTC1520</a>	LVDS-Compatible Quad Receiver	100mV Threshold, Low Channel-to-Channel Skew
<a href="#">LTC1535</a>	2500V Isolated RS485 Transceiver	Full-Duplex, Self-Powered Using External Transformer
<a href="#">LTC1685</a>	52Mbps RS485 Transceiver	Industry-Standard Pinout, 500ps Propagation Delay Skew
<a href="#">LTC1686/LTC1687</a>	52Mbps Full-Duplex RS485 Transceivers	LTC490/LTC491 Pin Compatible
<a href="#">LTC1688/LTC1689</a>	100Mbps Quad RS485 Drivers	Highest Speed, LTC486/LTC487 Pin Compatible
<a href="#">LTC1690</a>	Full-Duplex RS485 Transceiver with Fail-Safe	$\pm$ 15kV ESD, LTC490 Pin Compatible
<a href="#">LT1785/LT1785A</a>	$\pm$ 60V Protected RS485 Transceivers	$\pm$ 15kV ESD, Fail-Safe (LT1785A)
<a href="#">LT1791/LT1791A</a>	$\pm$ 60V Protected Full-Duplex RS485 Transceivers	$\pm$ 15kV ESD, Fail-Safe (LT1791A)
<a href="#">LTC2850/LTC2851/ LTC2852</a>	3.3V Supply RS485 Transceivers	$\pm$ 15kV ESD, 20Mbps, 900 $\mu$ A Supply Current, Fail-Safe
<a href="#">LTC2854/LTC2855</a>	3.3V Supply RS485 Transceivers	$\pm$ 15kV ESD, 20Mbps, 900 $\mu$ A Supply Current, Integrated Switchable Termination
<a href="#">LTC2856/LTC2857/ LTC2858</a>	20Mbps RS485 Transceivers	$\pm$ 15kV ESD, 900 $\mu$ A Supply Current, Fail-Safe
<a href="#">LTC2859/LTC2861</a>	20Mbps RS485 Transceivers	$\pm$ 15kV ESD, 900 $\mu$ A Supply Current, Integrated Switchable Termination
<a href="#">LTC2862/LTC2863/ LTC2864/LTC2865</a>	$\pm$ 60V Protected RS485 Transceivers	3V to 5.5V Supply, $\pm$ 15kV ESD, $\pm$ 25V Common Mode Range, 20Mbps or 250kbps
<a href="#">LTM2881</a>	Complete Isolated RS485 Transceiver	2500V <sub>RMS</sub> Isolation, Isolated DC Power (5V at Up to 200mA), 3.3V or 5V Operation, No External Components Required